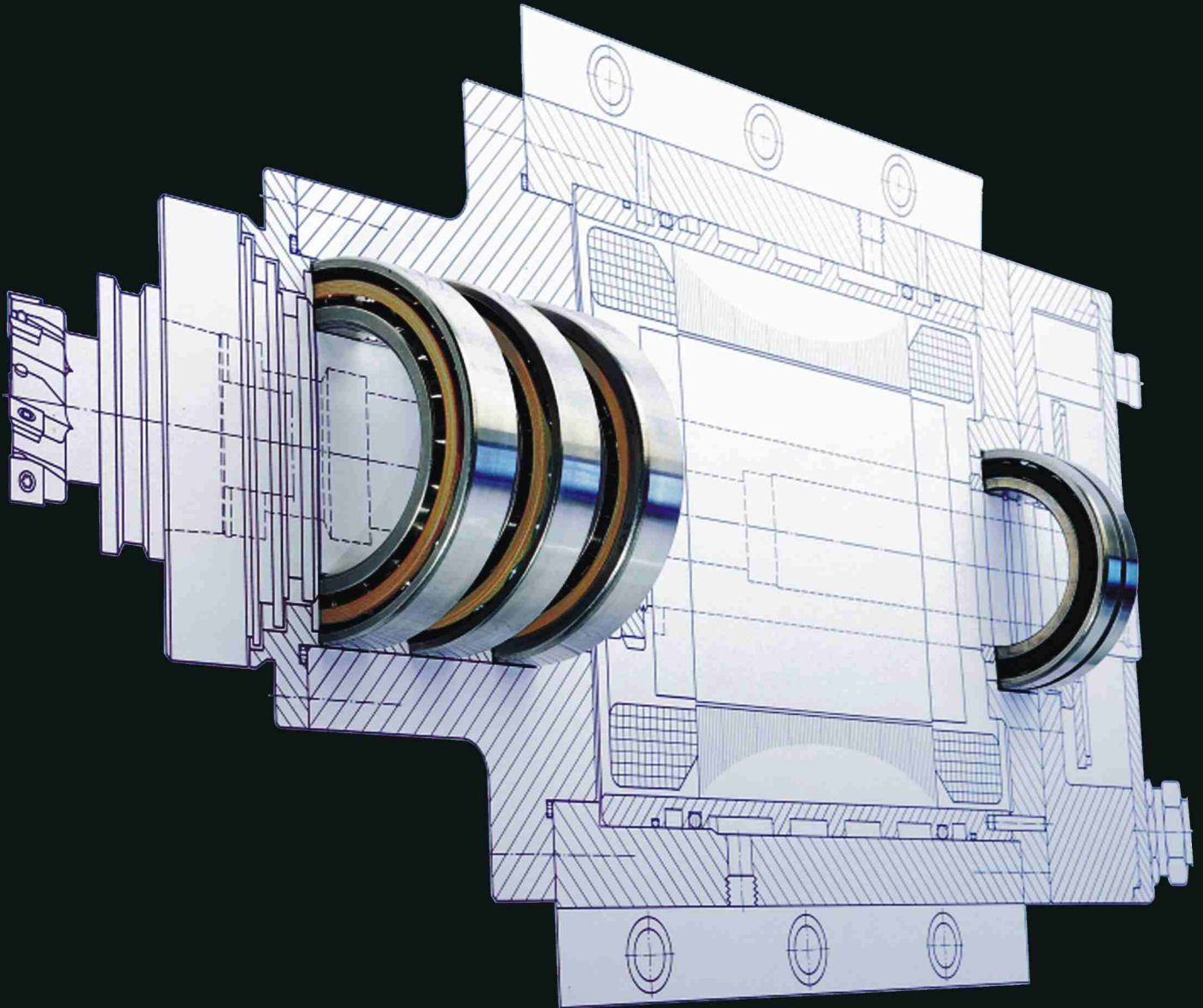


We have the solution...

...the future has a name



Reg.-Nr. 17581-04



Reg.-Nr. 17581-04

**LUBCON® Lubricants  
for High Speed Rolling Bearings**

Your Partner  
for the Lubrication of Bearings



The **LUBRICANT CONSULT GMBH** is one of the leading developers and manufacturers of famous high performance lubricants which guarantee the perfect lubrication of your high speed rolling bearings.

This high efficiency of the lubricants is proven by

- long service life
- good running behaviour
- high operating reliability



The extraordinary performance of the **LUBCON lubricating greases** is the result of the clearly defined selection of the thickener and its portion, the type of the base oil and its viscosity as well as the selected additives.

A **quality and environment management** introduced in June 1996 has strictly ensured that only raw materials be used without any ingredients that are harmful to the environment. In the production a technically sophisticated circulatory system is used to preserve the environmental resources as much as possible.

**LUBCON products are not liable to identification marking.**

In many operating assays on test stands in the laboratory as well as in practice at famous rolling bearing manufacturers, the application ranges of the greases are thoroughly screened taking into account the different types of construction and sizes of the rolling bearings.

**LUBCON** offers unique **special lubricating greases** with excellent operating properties and very good running times for your high speed rolling bearings.

**For the three most important operating parameters, i. e.**

- high temperature
- high load
- high speed

the well-established **LUBCON high performance lubricating greases** are indicated in tables and diagrams listing various technical data, successfully passed test runs, compatibility with plastics as well as their resistance to water and aggressive media.

The selection of the appropriate lubricant is an important factor with regard to long-time functioning, high operating reliability and efficiency of your bearings, therefore **LUBCON** offers you a **free** consultation and **complete** assistance - before, during and after your purchase of **LUBCON lubricants**.

Your very individual demands will be registered and translated into products that are especially developed for your company.

In this brochure you will find additional information on the running-in process necessary for the bearings, to be effected during operation at high speeds.



**Fig. 1:** High speed spindle bearing (SKF, D-Schweinfurt)

#### **Please note:**

This brochure only contains product information. For specific information please refer to our technical data and safety data sheets. The indications made represent the present state of development and knowledge of **LUBRICANT CONSULT GMBH**. Subject to change. The products are subject to severe controls of manufacture and comply in full with the specifications set forth by our company, but due to the multitude of different influencing factors, we cannot assume any warranty for the successful application in each individual case. Therefore, we recommend to perform field tests. We strictly refuse any liability.



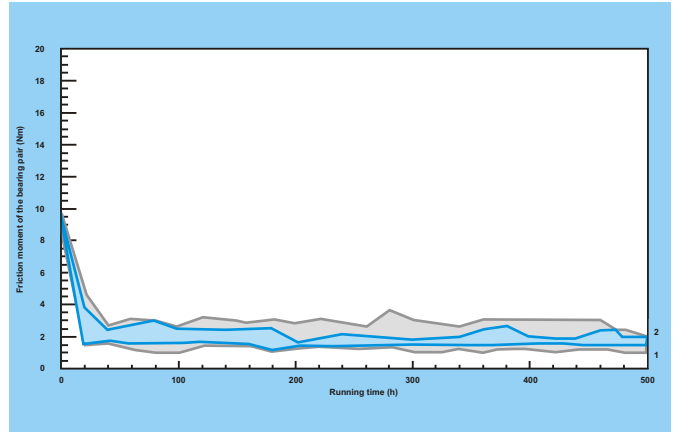
# Schedule of the Lubricating Greases



The loads possibly occurring when using different types of bearing constructions are shown in the following table.

**Table 1:**

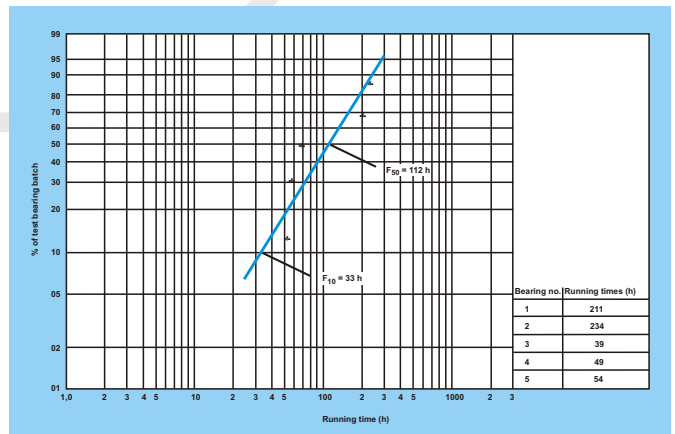
Technical Data	TURMOGREASE® Highspeed L 182	TURMOGREASE® Highspeed L 252	THERMOPLEX® 2 TML	TURMOGREASE® Li 802 EP
Base oil type	PAO/Ester	PAO/Ester	Ester	Min/SHC
Thickener	Li special	Li special	Li	Li
Service temperature range (°C)	-70 ... +120	-50 ... +120 (140)	-35 ... +160	-35 ... +140
Density +15 °C DIN 51751 (g/ml)	0.94	0.92	0.98	0.9
Consistency	2	2	2	2
Base oil viscosity DIN 51562 (mm <sup>2</sup> /s) +40 °C/+100 °C	18/4.5	25/6	55/9	82/12.5
Drop point (°C) DIN ISO 2176	> +250	> +250	> +180	> +190
Speed factor $n \cdot d_m$ (min <sup>-1</sup> · mm)	Kula 2 500 000 Kerola 200 000	Kula 2 200 000 Kerola 300 000	Kula 1 300 000 Kerola 300 000	Kula 1 000 000 Kerola 300 000
Corrosion protection acc. to SKF Emscor DIN 51802	0 - 0	0 - 0	0 - 0	0 - 0
Water resistance DIN 51807	1 - 90	1 - 90	1 - 90	1 - 90
Resistance to bases and acids	no	no	no	no
Compatibility with NBR, FKM, PTFE and PA 6.6	yes	yes	yes	yes
Oil separation DIN 51817 (%) at +40 °C/+100 °C	2.9/4.9	1.5/8.5	2.8/8.9	0.8/1.4
Content of solid foreign matter, particles 25 µm (mg)	< 5	< 5	< 5	< 5
FE9 test DIN 51821 F <sub>50</sub> (h)	A/1.5/6000-100 > 800 A/1.5/6000-120 > 200	A/1.5/6000-120 > 400	A/1.5/6000-140 > 800 A/1.5/6000-160 > 100	A/1.5/6000-140 235
FE8 test DIN 51819 successful tests	--	050-6000/5-90	050-7.5/80-135 050-3000/10-144 048-3000/10-130	050-6000/5-90 048-3000/10-100 048-75/50-45
VKA welding load DIN 51350 Pt. 4 (N)	2200/2400	2200/2400	2600/2800	3000/3200
Start-torque ASTM D 1478 (mNm)	265/-40 °C	150/-40 °C	--	--
Running-torque ASTM D 1478 (mNm)	26/-40 °C	19.5/-40 °C	--	--



**Diagram 1:**  
FE8 test run with tapered roller bearing 536048 ( $\cong$  31312); axial load  $F_a = 10 \text{ kN}$ ; speed  $n = 3000 \text{ min}^{-1}$ ; time of operation 500 h  
Lubrication with **TURMOGREASE® Li 802 EP**

**Table 2:**

Parameters	Test run 1	Test run 2	FAG requirements
Steady-state temperature in °C	100	95	120
Peak temperature in °C	116	110	120
Wear in mg of - the rolling element - the cage - the inner ring - the outer ring Frictional behaviour over the time (see diagram above)	14/11 15/11 4/4 1/2 Running-in finished	10/8 43/9 4/1 0/1 Running-in finished	< 35 <100 <b>Evaluation: very good</b>



**Diagram 2:**  
FE9 test run with angular contact ball bearings 529689 (7206 B), mounting type A, i. e. open bearing; axial load  $F = 1,5 \text{ kN}$ ; speed  $n = 6000 \text{ min}^{-1}$ ; temperature  $+160 \text{ °C}$   
Lubrication with **THERMOPLEX® 2 TML**

Service life of the grease in the test bearings in h: according to the Weibull diagram  $F_{50} = 112 \text{ h}$ ;  $F_{10} = 33 \text{ h}$   
Requirement in acc. with FAG and DIN 51825  $F_{50} = 100 \text{ h}$  →  
**Evaluation: fully meets the requirements**

# LUBCON lubricating Greases for High Speed Rolling Bearings



The four **LUBCON lubricating greases** for high speed rolling bearings are suitable for the lubrication of

- standard steel-steel spindle bearings
  - single and double row cylindrical roller bearings of a particularly high accuracy
  - tapered roller bearings with increased operating precision
  - high speed spindle bearings with small balls of steel
- "hybrid bearings" particularly efficient spindle bearings ( $\times DF > 1.3$  millions  $n \cdot d_m$ ), consisting of silicium nitride.

**Advantages of hybrid bearings:** lighter than steel-steel spindle bearings, high hardness and thermal resistance, good dimensional stability at highest temperatures, good corrosion resistance, high modulus of elasticity, absence of magnetism.

## Application in the field:

The lubricating greases

**TURMOGREASE® Highspeed L 182** and  
**TURMOGREASE® Highspeed L 252**

are used in spindle bearing arrangements of machine tools, e. g. grinding, milling and motor spindle units (spindle units driven by an integrated motor).

In a three-phase motor with frequency converter supply, the lubricating greases

**TURMOGREASE® Highspeed L 252**,  
**THERMOPLEX® 2 TML** and

**TURMOGREASE® Li 802 EP** are equally used because the speed factors prevailing here run up to 0.8 million ( $\text{min}^{-1} \cdot \text{mm}$ ).

## Product Description:

The lubricating greases **TURMOGREASE® Highspeed L 182** and **TURMOGREASE® Highspeed L 252** contain the base oil E/PAO (ester/poly-alpha-olefins) and show a low viscosity. The thickeners are special lithium soaps.

From the FE9 results it becomes obvious that a relatively high upper limit of the service temperature range of  $+120\text{ °C}$  is found in both high speed lubricating greases.

## Application:

**TURMOGREASE® Highspeed L 182** and **TURMOGREASE® Highspeed L 252** are preferably used in spindle bearings and cylindrical roller bearings of a bore size below  $d = 100\text{ mm}$  of the inner ring. The low viscosity base oil has proven of good results in the lubrication of high speed bearings.

**TURMOGREASE® Highspeed L 182** is also particularly suitable for smaller rolling bearings ( $d < 25\text{ mm}$ ) and very high speed factors (above  $n \cdot d_m = 2.5\text{ min}^{-1}$ ) as well as for the use at very low temperatures and applications requiring a very favourable frictional behaviour.

The lubricating grease **TURMOGREASE® Highspeed L 252** is regarded as universal grease for high speed rolling bearings; from the FE8 test run ( $d = 60\text{ mm}$ ) successfully passed you can see that it is suitable as well for larger rolling bearings.

For several years this grease has proven to be particularly favourable when used in high speed spindle bearings with ceramic balls (hybrid bearings).

The application of **TURMOGREASE® Highspeed L 182** and **TURMOGREASE® Highspeed L 252** at moderate temperatures, e. g.  $+60\text{ °C}$  or lower, leads to extremely high service lives.

The soaps of these greases keep the oil output during the application on a low but sufficient level, the same as with often low service temperatures. A lack of grease after a long service time (noticeable by temperature peaks) will be compensated by an increased oil output and grease mobility - without leading to a premature grease ageing.

A running-in is required for such greases to ensure the distribution of the lubricating grease. After expiry of the grease service life, the bearings have to be cleaned, newly greased and again submitted to a running-in process.

## Product Description:

The lubricating greases **THERMOPLEX® 2 TML** and **TURMOGREASE® Li 802 EP** are equipped with a base oil of a higher viscosity and, in addition, contain EP substances to increase the load carrying capacity. The thickeners are normal lithium soaps.

Furthermore, the lubricating grease **THERMOPLEX® 2 TML** stands out for a particularly high upper limit of the service temperature of  $+160\text{ °C}$ , with short peaks up to  $+180\text{ °C}$ .

## Application:

Both greases are equally suitable for high speed factors of  $> 0.8$  million ( $\text{min}^{-1} \cdot \text{mm}$ ). With such speed factors, perform the running-in process to assure the grease distribution and refrain from relubrication.

With speed factors below 0.8 million ( $\text{min}^{-1} \cdot \text{mm}$ ) you might as well proceed to a relubrication. Owing to their special composition, both greases are very well suitable for applications where higher loads and/or higher temperatures add to a high speed factor.

The lubricating grease **THERMOPLEX® 2 TML** should be used particularly in such cases where very high temperatures prevail. These can occur when the heat discharge from the bearing is hindered by the design of the mounting arrangement, or when heat from the environment is radiated towards the bearing.

Due to its higher viscosity of the base oil **TURMOGREASE® Li 802 EP** shows excellent properties even with larger spindle bearings ( $d > 100\text{ mm}$ ) at speed factors below 1 million ( $\text{min}^{-1} \cdot \text{mm}$ ).



In order to achieve the best results for your company with **LUBCON lubricants**, please observe the instructions for the lubrication and the running-in of the rolling bearings. Before the lubrication, largely remove the mostly mineral based preservation oil to avoid any weakening of the synthetic base oil of the lubricating greases.

Only **TURMOGREASE® Li 802 EP** contains a mineral base oil which is compatible with the standard preservation oils.

**Removal of the Preservation Oil:** Clean all bearing parts, also the spindle cage, with an appropriate cleansing agent (white spirit, alkaline cleanser).

Then, after having thoroughly dried these parts, it is important to proceed immediately to the application of the lubricating grease in order to avoid any corrosion.

**Capped Bearings:** The grease quantity should fill almost 30 % of the free bearings space. Upon demand, the bearing manufacturers or **LUBCON** indicate the grease quantity favourable for the lubrication of the different bearing constructions and sizes.

Apply the grease as uniform as possible over the whole bearing surface. It is useful to take a grease gun for that purpose which **LUBCON** would like to quote and supply.

**Open Bearings:** You may count with a grease quantity of up to 100 % of the free bearing space in order to achieve an increase of the service life. The cage space adjacent to the bearing must be large enough to easily receive the grease emerging from the bearing.

**Reduction of the Grease Quantity by 30 to 50 %:** to be effected in the interests of a fast and simple running-in process with lubricating greases causing temperature peaks during the running-in and distribution of the grease.

**Diagram 3, p. 8** shows the bearing temperature curve as a function of the operating times of two bearings B 7006 C.T (marked with A and B) of a spindle lubricated with **TURMOGREASE® Highspeed L 252**, degree of the grease filling 100 %, maximum target speed = 30,000 min<sup>-1</sup>.

The running-in starts at a speed of 10,000 min<sup>-1</sup>, which is approx. one third of the maximum speed of operation.

It can be proved (see **p. 10, table 5, test 2**) that this lubricating grease leads to a very low bearing friction. When starting the spindle there are no temperature peaks to be observed, after a few minutes both spindle bearings have already reached a temperature which remains almost unchanged over hours.

The speed raised up to the operational value of 30,000 min<sup>-1</sup> produces only a gradual increase of the temperature, after about one hour the steady state temperature of +42 °C is nearly reached.

### Field Test with **TURMOGREASE® Highspeed L 252:**

At the Gildemeister company a running-in without any problems was observed in larger spindle bearings  $d_m = 75$  mm at speed factors below 1 million (min<sup>-1</sup> · mm) and showing similar steady state temperatures of +35 to +44 °C at the outer rings of the bearings.

**In the running-in process TURMOGREASE® Highspeed L 252 was clearly superior compared to other competitive products.**

During the first two service hours, the operational speed shall be limited to a value of 30 % of the maximum speed, then any running-in prescription will not apply for speed factors up to 1.3 million (min<sup>-1</sup> · mm) for steel-steel as well as for hybrid bearings.

**Diagram 4, p. 8** shows the temperature curve during a running-in process at a speed factor of 1.6 million (min<sup>-1</sup> · mm) in dependence on the operating time of two hybrid bearings HC 7006 C.T. The running-in was started at a speed of 20,000 min<sup>-1</sup> and raised after just one hour to maximum speed of 40,000 min<sup>-1</sup>. With an almost completely filled bearing, no perceptible temperature peaks occurred.

**Table 3, p. 8** shows you a simplified running-in prescription for a large speed factor range regarding the applied lubricating grease **TURMOGREASE® Highspeed L 252**.

### Service Lives of Greased High Speed Rolling Bearings

The rolling bearings operated at high speed factors, i. e. range from 0.6 to 2.5 million (min<sup>-1</sup> · mm), are preferably lubricated by **TURMOGREASE® Highspeed L 182** and **TURMOGREASE® Highspeed L 252**.

After expiry of the grease service life, a relubrication should not be carried out because the new grease in addition to the used grease would lead to an overlubrication of the bearing and a new running-in would not be possible within an acceptable delay. Furthermore, in most cases a sufficient space is missing to receive the displaced used grease. Therefore it is recommended to clean the bearing and to apply new grease.

The grease service life is shown in the right part of the lubrication interval/grease service life diagram (**diagram 5, p. 9**).

**Upper range limit:** applies to the particularly efficient ceramic hybrid spindle bearings.

**Lower range limit:** applies to the standard steel-steel spindle bearings.

The rolling bearings greased with **THERMOPLEX® 2 TML** and **TURMOGREASE® Li 802 EP** may be relubricated if the speed factor is below 0.6 million (min<sup>-1</sup> · mm).

Make sure that the relubrication will be effected while the bearings are running at a low speed and that the lubrication of the bearing will be complete. A sufficiently large space to receive the used grease must be provided.

The relubrication quantity is to be determined according to **table 4, p. 9**.

In case of higher speed factors > 0.6 million (min<sup>-1</sup> · mm), it is recommended to lubricate the bearings with new grease after expiry of the grease service life. The service life of the grease is to be determined from the coloured part of the diagram (**diagram 5, p. 9**).

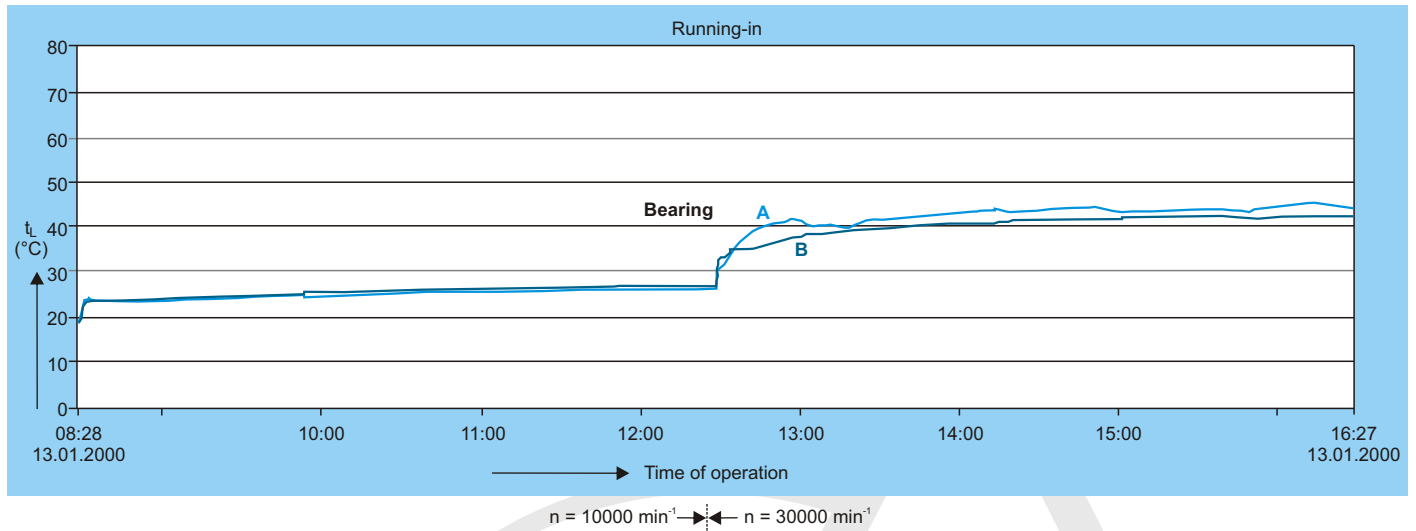
It has to be taken into account that the grease service life of various equally loaded bearings may differ by approx. 1 : 3. If a high reliability is desired, the lower part of the range should be selected.

**TURMOGREASE® Li 802 EP** should not be used for ceramic hybrid spindle bearings and the lubricating grease **THERMOPLEX® 2 TML** only for such cases where temperatures above +60 °C are to be expected.

# Test Results and Running-in Prescription

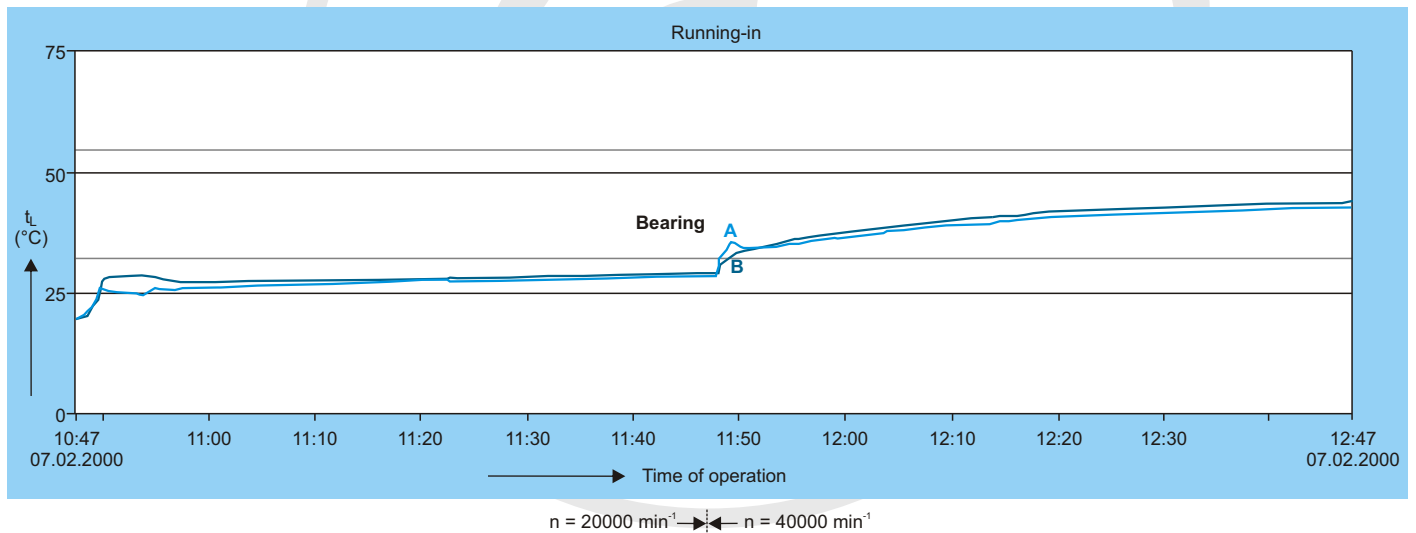


**Diagram 3:**  
Running-in  $n \cdot d_m = 1.3$  million ( $\text{min}^{-1} \cdot \text{mm}$ )



Test stand	Rolling bearing	Lubricating grease	Filling degree of the free bearing space
WS 22	B7006C.T	TURMOGREASE® Highspeed L 252	100 %

**Diagram 4:**  
Running-in  $n \cdot d_m = 1.6$  million ( $\text{min}^{-1} \cdot \text{mm}$ )



Test stand	Rolling bearing	Lubricating grease	Filling degree of the free bearing space
WS 22	HC7006 C.T	TURMOGREASE® Highspeed L 252	100 %

**Table 3:**  
Running-in prescription for the lubricating grease TURMOGREASE® Highspeed L 252

Speed factor ( $\text{min}^{-1} \cdot \text{mm}$ )	Spindle bearing	Grease filling degree in % of the free bearing space	Running-in conditions: after start-up
up to 1.3 million	steel-steel	30 to 100	two hours at 30% of the maximum speed
up to 1.6 million	hybrid	30 to 100	two hours at 50% of the maximum speed





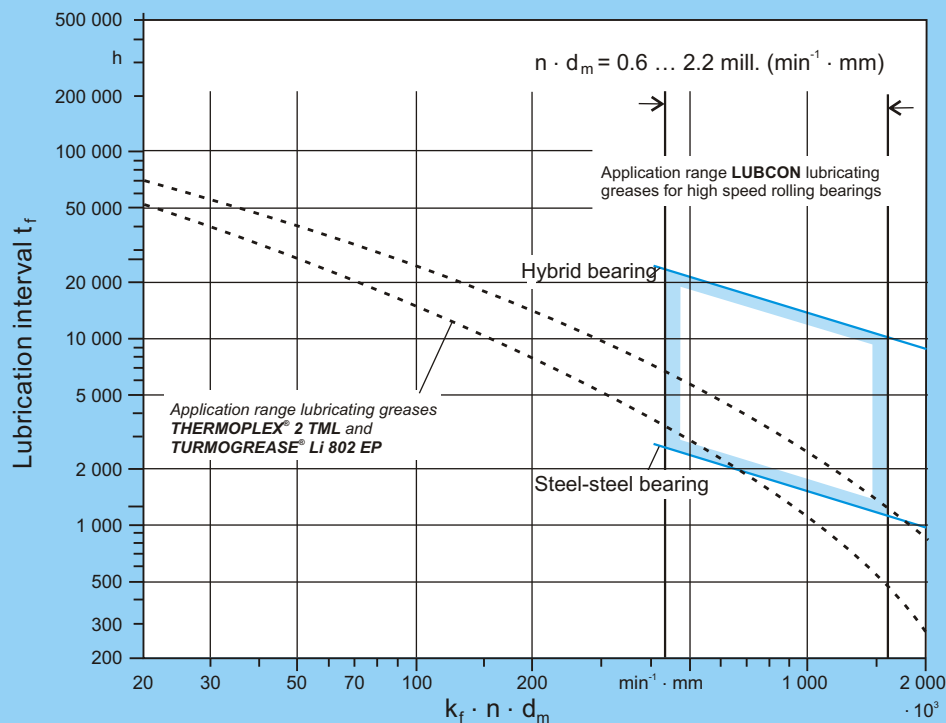
# Lubrication Interval and Relubrication Quantity Chart

**Table 4:**  
Relubrication quantities

Relubrication quantity $m_1$ for weekly or annual relubrication intervals	
$m_1 = D \cdot B \cdot x$ [g]	
Relubrication interval	x
weekly	0.002
monthly	0.003
annual	0.004
Relubrication quantity $m_2$ for extremely short relubrication intervals	
$m_2 = (0.5 \dots 20) \cdot V$ [kg/h]	
Relubrication quantity $m_3$ before starting reoperation after a standstill of several years	
$m_3 = D \cdot B \cdot 0.01$ [g]	
V = free space in the bearing	
$\approx \frac{\pi}{4} \cdot B (D^2 - d^2) \cdot 10^{-9} - \frac{G}{7800}$ [m <sup>3</sup> ]	
d = diameter of the bearing bore [mm]	
D = outer diameter of the bearing [mm]	
B = bearing width [mm]	
G = bearing weight [kg]	

**Diagram 5:**

Lubrication interval/grease service life dependent on the value  $k_f \cdot n \cdot d_m$  with the application range of the LUBCON lubricating greases for high speed rolling bearings.  $n$  = speed in  $\text{min}^{-1}$ ,  $d_m$  = reference circle of the bearing in mm



$k_f$	Rolling bearing
1	Cylindrical roller bearing of a higher dimensional accuracy (N10 ... K.M1.SP)
0,75	Spindle bearing (C) pressure angle 15°
0,9	Spindle bearing (E) pressure angle 25°
2,5	Tapered roller bearing of a higher dimensional accuracy (2344 ... M.SP)

# Results Obtained by LUBCON Lubricating Greases in Laboratory and Field Tests

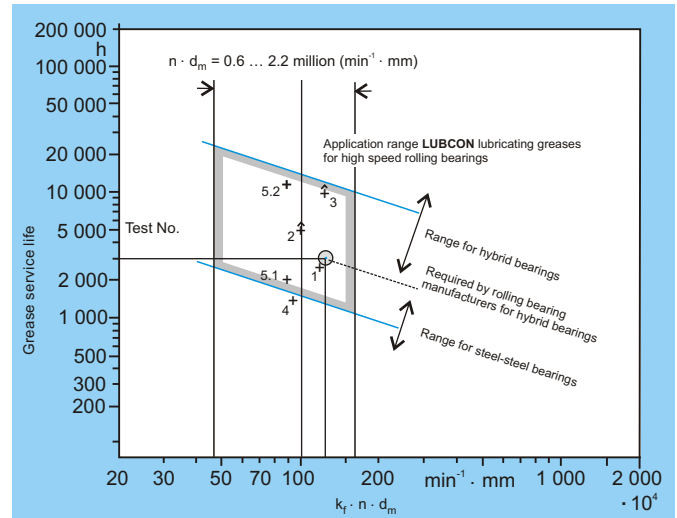


## For high speed rolling bearings: TURMOGREASE® High-speed L 182 and TURMOGREASE® Highspeed L 252

The results of the 5 test runs indicated in **table 5** are contained in the **diagram 6**. The **diagram 6** is the basis for the coloured range in **diagram 5**, p. 9 regarding the **LUBCON lubricating greases** for high speed rolling bearings. In the **diagram 6** the circle of the range of these results complies with the requirement demanded by the rolling bearing manufacturer for hybrid bearings.

The time of operation achieved by steel-steel bearings in **test 2** is by approx. 10 times higher than the times reached by competitive products. The time of operation reached by hybrid bearings in **test 3** is with more than 10 000 service hours extremely high, comparative values of lubricating greases of other manufacturers are not available, yet.

**Reason for such a high performance of TURMOGREASE® Highspeed L 252:** The bearing lubricated with this grease causes less than half the friction loss compared to measured competitive greases.



**Diagram 6:** Laboratory and field results with **LUBCON** lubricating greases used in high speed rolling bearings

**Table 5:**  
Results of various tests

Test no.	Test site/ test stand	Test bearing/ time of operation (h)	Grease/temperature (°C)	Speed (min <sup>-1</sup> )	n · d <sub>m</sub> (min <sup>-1</sup> · mm)	k <sub>f</sub> · n · d <sub>m</sub> (min <sup>-1</sup> · mm)
1	GMN spindle	SM 6005/>2700	TURMOGREASE® Highspeed L 182/60	> 46500	1.7 mill.	1.25 mill.
2	IKMT TU Hannover spindle	B 7008 C/>5000	TURMOGREASE® Highspeed L 252/64	24000	1.3 mill.	0.97 mill.
3	FAG WS 22n	HC7006C/>10 000	TURMOGREASE® Highspeed L 252/50	40000	1.7 mill.	1.27 mill.
4	GMN spindle	SM 6005/1500	TURMOGREASE® Highspeed L 252/60	35000	1.25 mill.	0.94 mill.
5	FAG WS 22a	B 7205C 2000-12 000	TURMOGREASE® Highspeed L 252/40	30000	1.15 mill.	0.86 mill.

## Other LUBCON Lubricating Greases for High Speed Rolling Bearings

After long years of experience, almost all cases of application regarding high speed rolling bearings can be mastered with the product line consisting of four **base greases**. Furthermore, there are cases where the lubricating grease should provide at least one more characteristic in order to achieve an optimum result.

Therefore, **other lubricating greases** were **derived from these base greases** thus showing at least one modified parameter. In addition to the existing properties at least one more specification was obtained. For further details see **table 6**.

**Table 6:**  
Other lubricating greases for high speed rolling bearings derived from the base greases

Base grease	Derived lubricating greases	Modified parameter	New product property
TURMOGREASE® Highspeed L 182	THERMOPLEX® 2 TML special	thickener	better frictional behaviour
TURMOGREASE® Highspeed L 252	TURMOGREASE® Highspeed LC 252	base oil, thickener	better resistance to water, bases and acids
THERMOPLEX® 2 TML	THERMOPLEX® L 552	thickener	better thermal quality,
	THERMOPLEX® 2 HPL	base oil	higher operating performance
TURMOGREASE® Li 802 EP	TURMOGREASE® L 802 EP+	thickener part, consistency	better running-in behaviour, higher operating performance

Whatever you need - from the consultation on tribologic questions to the setting into operation of the lubricant **LUBCON** is the partner at your side worldwide.

And that is not yet all ...

The **TOTAL LUBE MANAGEMENT** enables you to work even more efficient and more economic as before.

This performance spectrum includes

- **ELABORATION** of **lubricant charts** for your company
- **DELIVERY** of the **lubricants** determined in the **lubricant chart**
- **LUBRICATION** of the individual **plant installations** with the **lubricants** listed in the **lubricant chart**
- **DOCUMENTATION** of the **lubrication processes**
- **CONCEPTION** of the **lubricating systems** for oils and greases
- **SETTING INTO OPERATION** of the **lubricating systems**
- **PROCUREMENT** of **production means**, e. g. grease guns, grease nipples, lubricant supply systems, etc.
- **FILLING** of **small series of rolling bearings** with the greases indicated by you

Did you know that **LUBCON lubricants** are applied for your safety worldwide every day?

- e. g. in single-lever mixers of water fittings
- in energy regulators in electric stoves
- in the AIRBUS
- in the ARIANE carrier rocket
- in the FORMULA 1 by Sauber-Petronas, Jordan and Benetton
- in vehicle components lubricated for life
- in the food production with specially approved (NSF-H1) food lubricants
- in large open gear drives of cement mills, in small gears of dental turbines
- in large bearings in the open pit mining, in miniature bearings of computers
- in conveyor chains of paint dryers, in transport chains of refrigerating plants etc.

#### LUBCON delivery system:

... at the agreed date always the desired **LUBCON product** available to you:

... 100 ml tubes, 400 ml sprays, 400 ml cartridges, 1 kg cans, 5 l canisters, 20 l canisters, 5 kg buckets, 25 kg buckets, 180 kg drums, 200 l drums or the 1000 l container are just a small selection of the packing units possible...

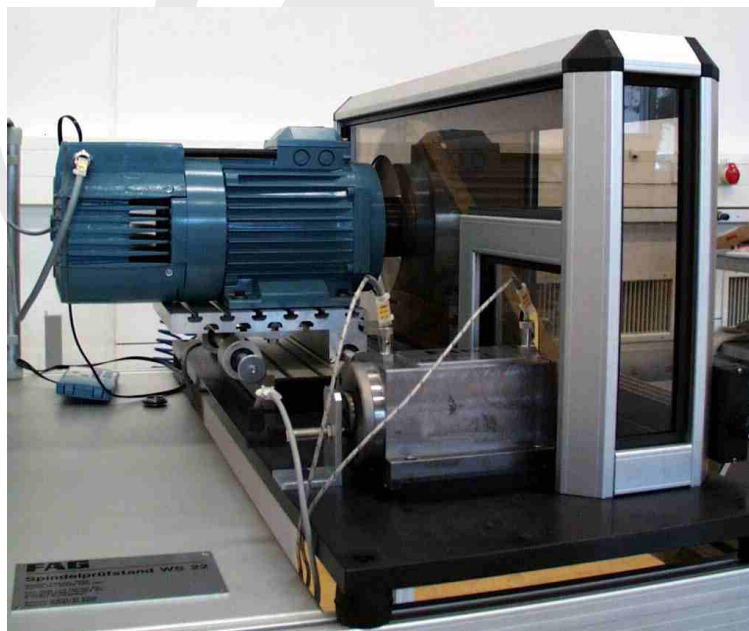


Fig. 2: Test Stand WS 22

#### Design/Layout:

Dipl. Designerin Andrea Dörn  
Nadja Grabowski, Marketing

#### Text:

Dr.-Ing. Erich Kleinlein  
Nadja Grabowski

#### Tables, Diagrams:

Prof. Dr. A. Tönsmann, FH, Gelsenkirchen



## The World of the LUBCON® Lubricants

### EUROPE

#### Austria

LUBRICANT CONSULT GMBH  
Office St. Gertraud  
GSM: +43-6644183187  
Fax: +43-4352-720 64  
E-mail: [austria@lubcon.com](mailto:austria@lubcon.com)  
[www.lubcon.com](http://www.lubcon.com)

#### Belgium

Van Meeuwen Special Lubricants N.V.  
Tel.: +32-53-76 76 00  
Fax: +32-53-21 52 03  
E-mail: [info@vanmeeuwen.be](mailto:info@vanmeeuwen.be)  
[www.vanmeeuwen.com](http://www.vanmeeuwen.com)

#### Czech Republic

LUBCON s.r.o.  
Tel.: +420-577-34 36 18  
Fax: +420-577-34 20 09  
E-mail: [czechrepublic@lubcon.com](mailto:czechrepublic@lubcon.com)  
[www.lubcon.com](http://www.lubcon.com)

#### Denmark

A.H. INTERNATIONAL A/S  
Tel.: +45-75-50 11 00  
Fax: +45-75-50 20 21  
E-mail: [ahi@ahi.dk](mailto:ahi@ahi.dk)  
[www.lubcon.dk](http://www.lubcon.dk)

#### Finland

Jukka Majuri Oy  
Tel.: +358-3-515 41 26  
Fax: +358-3-511 52 20  
E-mail: [jukka.majuri@lubcon.fi](mailto:jukka.majuri@lubcon.fi)  
[www.lubcon.fi](http://www.lubcon.fi)

#### France

LUBCON FRANCE S.A.R.L.  
Tel.: +33-4-79 84 38 60  
Fax: +33-4-79 84 38 61  
E-mail: [france@lubcon.com](mailto:france@lubcon.com)  
[www.lubcon.com](http://www.lubcon.com)

#### Great Britain

LUBCON Lubricants UK Ltd.  
Tel.: +44-1943-601431  
Fax: +44-1943-602645  
E-mail: [uk@lubcon.com](mailto:uk@lubcon.com)  
[www.lubcon.com](http://www.lubcon.com)

#### Italy

LUBCON LUBRIFICANTI S.R.L.  
Tel.: +39-0111-97 03 964  
Fax: +39-0111-97 03 974  
E-mail: [italia@lubcon.com](mailto:italia@lubcon.com)  
[www.lubcon.com](http://www.lubcon.com)

### EUROPE

#### Netherlands

Van Meeuwen Smeertechniek B.V.  
Tel.: +31-294-49 44 94  
Fax: +31-294-49 44 90  
E-mail: [info@vanmeeuwen.nl](mailto:info@vanmeeuwen.nl)  
[www.vanmeeuwen.com](http://www.vanmeeuwen.com)

#### Norway

NORIKO AS  
Tel.: +47-33-37 85 00  
Fax: +47-33-37 85 01  
E-mail: [bww@noriko.no](mailto:bww@noriko.no)  
[www.noriko.no](http://www.noriko.no)

#### Poland

LUBCON POLSKA Sp. z o.o.  
Tel.: +48-81-7 21 68 30  
Fax: +48-81-7 21 68 31  
E-mail: [polska@lubcon.com](mailto:polska@lubcon.com)  
[www.lubcon.com](http://www.lubcon.com)

#### Slovenia

LUBCON d.o.o.  
Tel.: +386-7-33 80 760  
Fax: +386-7-33 80 763  
E-mail: [lubcon@lubcon.si](mailto:lubcon@lubcon.si)  
[www.lubcon.si](http://www.lubcon.si)

#### Spain

LUBRITEC, S.A.  
Tel.: +34-93-719 11 13  
Fax: +34-93-719 12 57  
E-mail: [lubritec@lubritec.com](mailto:lubritec@lubritec.com)  
[www.lubritec.com](http://www.lubritec.com)

#### Sweden

Ringdahl Maskiner AB  
Tel.: +46-8-14 02 75  
Fax: +46-8-41 14 170  
E-mail: [clas@ringdahl-maskiner.se](mailto:clas@ringdahl-maskiner.se)  
Internet: [www.ringdahl-maskiner.se](http://www.ringdahl-maskiner.se)

#### Switzerland

LUBCON Lubricant Consult AG  
Tel.: +41-44-8 82 30 37  
Fax: +41-44-8 82 30 38  
E-mail: [swiss@lubcon.com](mailto:swiss@lubcon.com)  
[www.lubcon.com](http://www.lubcon.com)

#### Turkey

GEOCON Ltd. Şti.  
Tel.: +90-216-561 15 26  
Fax: +90-216-561 11 87  
E-mail: [geocon@geocon.com.tr](mailto:geocon@geocon.com.tr)  
[www.geocon.com.tr](http://www.geocon.com.tr)

### EUROPE

#### Further Distributors

Bulgaria	Ireland
Cyprus	Portugal
Greece	Russia
Hungary	

### NORTH AMERICA

#### United States

LUBCON Turmo® Lubrication, Inc.  
Tel.: +1-616-575-6034  
Fax: +1-616-575-6062  
Toll free US+CAN: 877-887-6658  
E-mail: [inquiry@lubconusa.com](mailto:inquiry@lubconusa.com)  
[www.lubconusa.com](http://www.lubconusa.com)

#### Further Distributors

Mexico

### SOUTH AMERICA

#### Brazil

Fuchs do Brasil S.A.  
Tel.: +55-11-4789-2311  
Fax: +55-11-4789-2670  
E-mail: [fuchs@fuchsbr.com.br](mailto:fuchs@fuchsbr.com.br)  
[www.fuchsbr.com.br](http://www.fuchsbr.com.br)

#### Further Distributors

Ecuador

### AFRICA / MIDDLE EAST

#### South Africa

FOCHEM International (Pty) Ltd.  
Tel.: +27-11-903-9720  
Fax: +27-11-903-9730  
E-mail: [info@fochem-international.com](mailto:info@fochem-international.com)

#### Further Distributors

Egypt	Saudi Arabia
Israel	Tunisia
Iran	UAE
Pakistan	

### ASIA/PACIFIC

#### Philippines

LUBCON Lubricant Asia  
Regional Headquarter  
E-mail: [apsales@lubcon.com](mailto:apsales@lubcon.com)

#### Further Distributors

Australia	Korea
Bangladesh	Malaysia
China	New Zealand
Hong Kong	Singapore
India	Taiwan
Indonesia	Thailand
Japan	Vietnam

## LUBRICANT CONSULT GMBH

Lubricants • Lubrication Systems

Gutenbergstraße 13 • 63477 Maintal • GERMANY • P.O. Box 200 240 • 63469 Maintal • GERMANY  
Tel.: +49 6109/7650-0 • Fax: +49 6109/7650-51 • Email: [webmaster@lubcon.com](mailto:webmaster@lubcon.com) • [www.lubcon.com](http://www.lubcon.com)